



Lasertack New Laser Generation

OEM-S-589/1~50mW



LD PUMPED ALL-SOLID-STATE GREEN LASER

All solid state laser at 589nm is made features of ultra compact, small size, wide operating temperature, good sealing, long lifetime, low cost and easy operating, working under the pressure of 0.02kPa, which is used in scientific experiment, optical sensor, measurement, instrument, communication, spectrum analysis, etc.



SPECIFICATIONS

Wavelength (nm)	589±1
Operating mode	CW
Output power (mW)	>1,5,10,20,...,50
Power stability (rms, over 4 hours)	<1%, <3%, <5%
Transverse mode	TEM ₀₀
M ² factor	<1.5
Beam diameter at the aperture(1/e ² ,mm)	0.7±0.05
Beam divergence, full angle (mrad)	<1.5
Polarization ratio	>100:1 Horizontal±5 degree (Vertical Optional)
Pointing stability after warm-up (mrad)	<0.05
Pointing stability Over Temp. (μrad/°C)	<8
Warm-up time (minutes)	<5
Beam height from base plate (mm)	19
Power Consumption(W)	<30
Shock Tolerance(6ms)	7g laterally, 15g vertically
IP Rating	IP65
Power supply(90-264VAC or 5VDC)	PSU-III-OEM-97
Operating temperature (°C)	10-35
Max. Heat Dissipation of Head(W)	4W@25°C
Modulation	TTL on/off, 1Hz-1KHz, 1KHz-10KHz, 10KHz-30KHz; and Analog modulation option
Expected lifetime (hours)	10000
Warranty	1 year



OEM-S-589

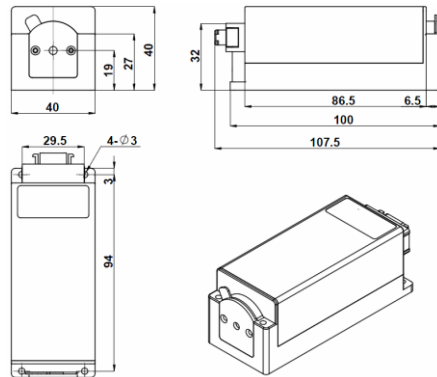

100 (L) × 40 (W) × 40(H) mm³, 0.41kg

PSU-III-OEM-97

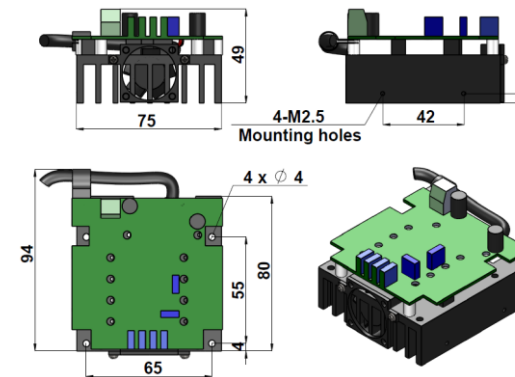

94(L) × 75(W) × 49(H)mm³, 0.23kg